



KEY SPECIFICATIONS

30W POWER	5YR* WARRANTY	EPISTAR LED's inside
IP66	3600 LUMENS	

Specification	Flood 30W
System Power	30W
Driver Manufacturer	Mean Well
LED Chipset	Epistar
Colour Rendering Index	>85
Lumen Output	3600Lm
LED Efficacy	120 Lm/cW
Dimmable	Contact Office
Power Factor	0.97
IP Rating	IP66
Colour Temperature	5700K
Housing Material	High Grade 6063 Aluminium
Lens Material	Tempered Glass
Input Voltage	AC200-240V, 47-63Hz
Operating Temperature	-20 to 50 °C
Cable Flex	1m
Weight	1.5kg
Dimensions	215mm x 175mm x 47mm
MacAdam Step	2.8
Lifetime	50,000 hours, L70-B10 (Ta 25 °C)

* Warranty terms and conditions apply

TECHNICAL DRAWINGS

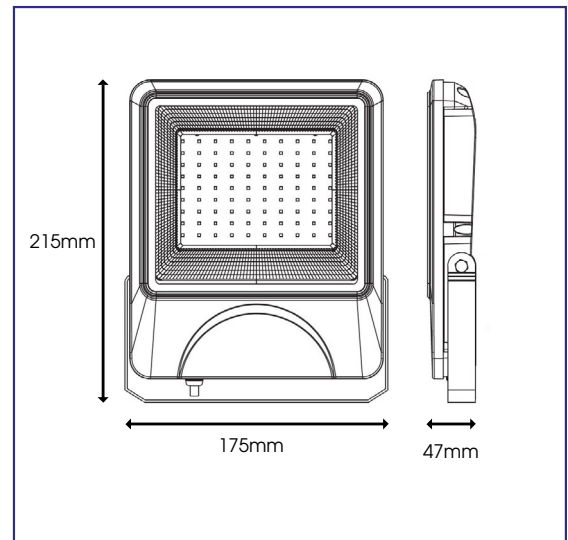

LUMINOUS INTENSITY DISTRIBUTION DIAGRAM

