

C-BATTEN LINEAR

CTBATTEN-1500-NW-45



KEY SPECIFICATIONS

45W POWER	5YR* WARRANTY	EPISTAR LED's inside
IP20	4500 LUMENS	LIFUD Driver as Standard

Specification	Linear Batten
System Power	45W
LED Chipset	Epistar
Driver Manufacturer	Lifud
Colour Rendering Index	>85
Lumen Output	4500Lm
LED Efficacy	100 Lm/cW
Power Factor	0.9
IP Rating	IP20
Beam Spread	120 °
Colour Temperature	4000K
Housing Material	Aluminium
Diffuser Type	Polycarbonate
Operating Temperature	-20 to 50 °C
Input Voltage	AC 200-240V, 47-63Hz
Weight	1.2kg
Dimensions	1500mm x 50mm x 56mm
MacAdam Step	2.8
Lifetime	50,000 hours, L70-B10 (Ta 25 °C)

* Warranty terms and conditions apply

TECHNICAL DRAWINGS

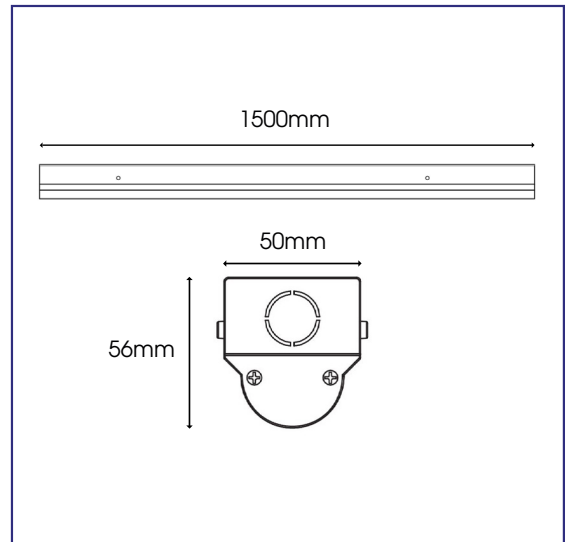

LUMINOUS INTENSITY DISTRIBUTION DIAGRAM

